

VPI P/N: 6A-PLG-STRANDED

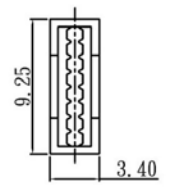

Insert

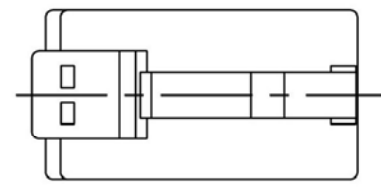
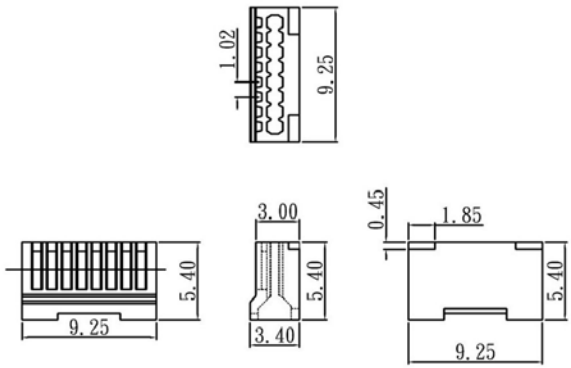
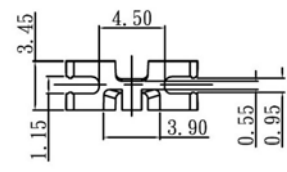
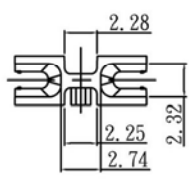
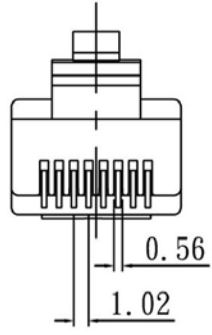
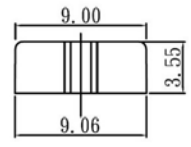
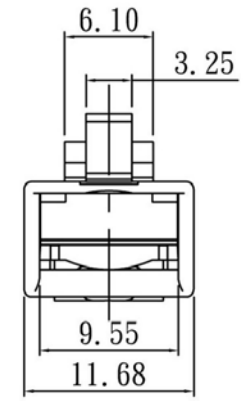
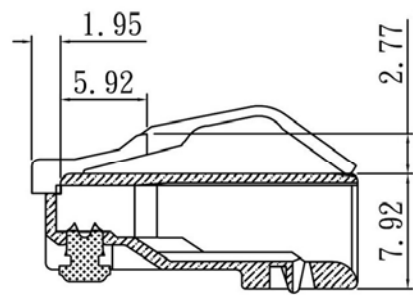

[Wire-Fixer]

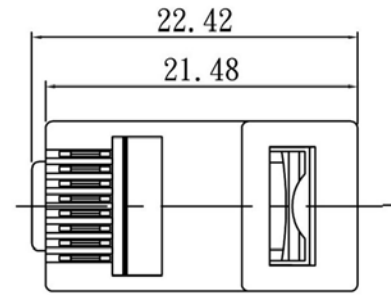

MECHANICAL SPECIFICATION :

1. Housing Material: Polycarbonate, UL 94V-2.
NO Poison
2. Material Contact: 6U" Below Brass.
15U" Above Phosphor Bronze.
3. Contact area plated gold over 50U"
4. Housing Color: Transparent
5. Operating Temperature: -40°c to 80°c.
6. Sheet copper thickness: 0.3mm

UNIT: m/m