

VPI P/N: CVR-RJ45JCK

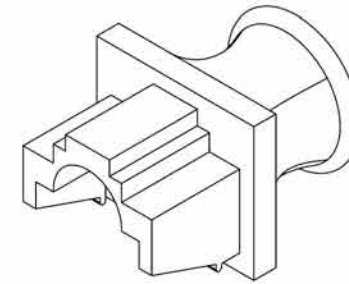
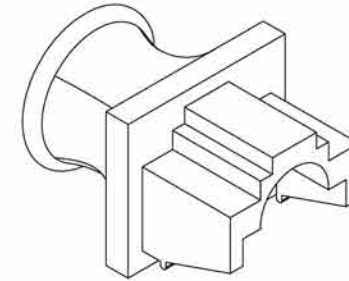
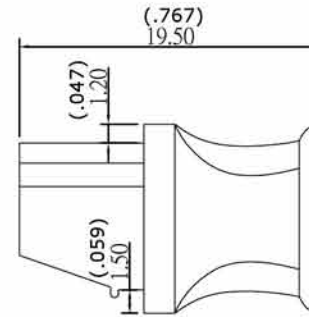
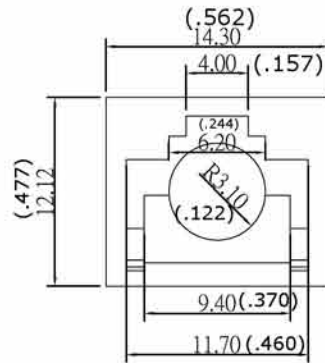
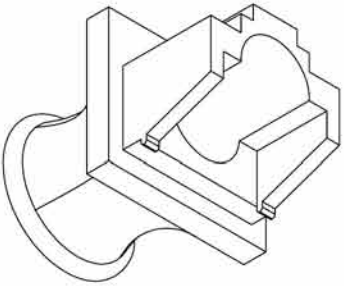
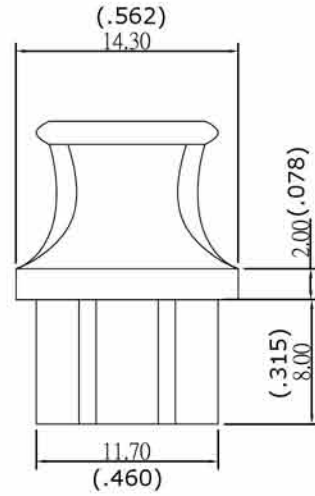
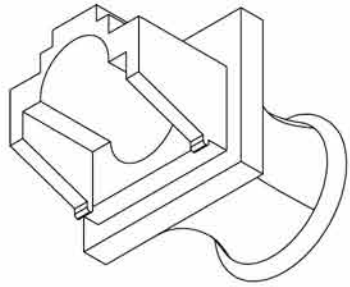

Material:
Boot :PVC
NOTE TOL:±0.1
Units: mm (inch)